

Surface Mount Multilayer Varistor

SV1812N380G0A

Description

The SV1812N380G0A is based on Multilayer fabrication technology. These components are designed to suppress a variety of transient events, including those specified in IEC 61000-4-2 or other standards used for Electromagnetic Compliance (EMC). The SV1812N380G0A is typically applied to protect integrated circuits and other components at the circuit board level. It can operate over a wider temperature range than zener diodes.



Features

- ◆ Rectangle, sizes serialization for hybrid integrated circuit or printed circuit surface mount components
- ◆ There are many side electrode lead-out material, particularly suitable for surface mount technology for solderability and resistance to soldering heat of the stringent requirements
- ◆ Fast response (<1ns)
- ◆ Low leakage current, low clamping voltage
- ◆ Suitable for reflow, wave soldering and hot air hand soldering

Applications

- ◆ Application for Mother Board, Notebook, Cellular Phone, PDA, handheld device, DSC, DV, Scanner, and Set- Top Box...etc.
- ◆ Suitable for Push-Button, Power Line and Low Frequency single line over-voltage protect.

Surface Mount Multilayer Varistor

SV1812N380G0A

Electrical Characteristics (25±5°C)

Symbol	Minimum	Typical	Maximum	Units
V_{RMS}	—	—	30	V
V_{DC}	—	—	38	V
V_V	45.6	—	57	V
V_C	—	—	125	V
I_{max}	—	—	800	A
W_{max}	—	—	1.5	J

V_{RMS} - Maximum AC operating voltage the varistor can maintain and not exceed 10μA leakage current.

V_{DC} - Maximum DC operating voltage the varistor can maintain and not exceed 10μA leakage current.

V_V - Voltage across the device measure at 1mA DC current.

Equivalent to V_B "breakdown voltage".

V_C - Maximum peak current across the varistor with 8/20μs waveform and 10A pulse current.

I_{max} - Maximum peak current which may be applied with 8/20μs waveform without device failure.

W_{max} - Maximum energy which may be dissipated with the 10/1000μs waveform without device failure.

Surface Mount Multilayer Varistor

SV1812N380G0A

Dimensions

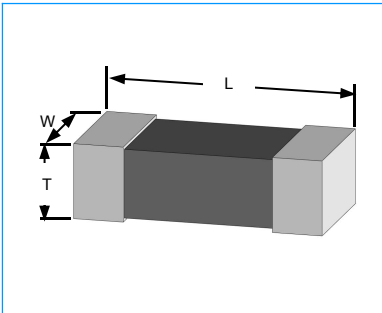

Size EIA (EIAJ)	Length (L)		Width (W)		Thickness (T)	
	Inches	Millimeters	Inches	Millimeters	Inches	Millimeters
1812 (4532)	0.177±0.016	4.50±0.40	0.126±0.008	3.20±0.20	0.126 Max	3.20 Max

Soldering Recommendations

● Recommended solder Pad Layout

Size EIA (EIAJ)	A		B		C		D	
	Inches	Millimeters	Inches	Millimeters	Inches	Millimeters	Inches	Millimeters
1812 (4532)	0.098~0.138	2.5~3.5	0.217~0.240	5.5~6.1	0.091~0.126	2.3~3.2	0.024~0.043	0.6~1.1

Avoid material run this area

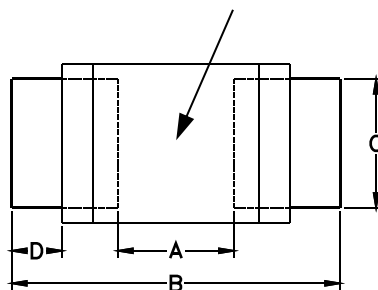

- The solder paste shall be printed in a thickness of 150 to 200µm.
- The SIR test of the solder paste shall be done (Base on JIS-Z-3284)

● IR Soldering

Rapid heating, partial heating or rapid cooling will easily cause defect of the component. So preheating and gradual cooling process is suggested. IR soldering has the highest yields due to controlled heating rates and solder liquidus times. Make sure that the element is not subjected to a thermal gradient steeper than 4 degrees per second. 2 degrees per second is the ideal gradient. During the soldering process, pre-heating to within 100 degrees of the solder peak temperature is essential to minimize thermal shock.

Surface Mount Multilayer Varistor

SV1812N380G0A

Soldering Recommendations (Continue)

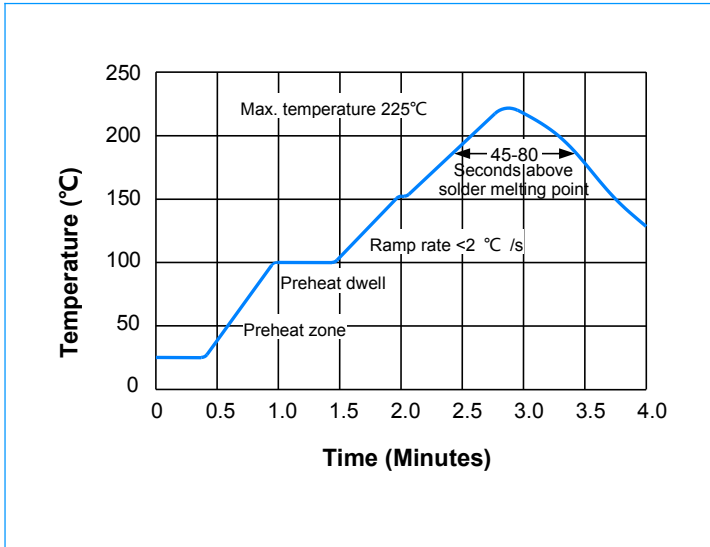

(a) Preheat

1. The temperature rising speed is suggested to be 2~4 °C /s
2. Appropriate preheat time will be from 60 to 120 seconds.

(b) Heating

1. Careful about sudden rise in temperature as it may worsen the solder ability.
2. Set the peak temperature in the range from 215 °C to 225 °C.

(c) Cooling

1. Careful about slow cooling as it may cause the position shift of component.

Surge Waveform

Wave shape "Short Circuit" (Current I_{sc})

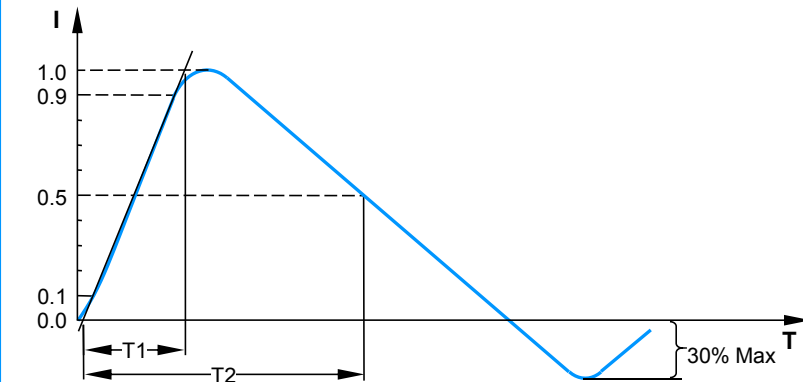

IEC 61000-4-2 Compliant ESD Current Pulse Waveform

IEC61000-4-5 Standards

SEVERITY LEVEL	T1	T2
1	8μs	20μs
2	10μs	1000μs

Surface Mount Multilayer Varistor

SV1812N380G0A

Environmental & Reliability Testing

Characteristic	Test method and description			
High Temperature Storage	The specimen shall be subjected to $125\pm 2^{\circ}\text{C}$ for 1000 ± 2 hours in a thermostatic bath without load and then stored at room temperature and humidity for 1 to 2 hours. The change of varistor voltage shall be within 10%.			
Temperature Cycle	The temperature cycle of specified temperature shall be repeated five times and then stored at room temperature and humidity for one two hours. The change of varistor voltage shall be within 10% and mechanical damage shall be examined.	Step	Temperature	Period
		1	$-40\pm 3^{\circ}\text{C}$	30min \pm 3
		2	Room Temperature	1~2hours
		3	$125\pm 2^{\circ}\text{C}$	30min \pm 3
		4	Room Temperature	1~2hours
High Temperature Load	After being continuously applied the maximum allowable voltage at 85°C for 1000hours, the specimen shall be stored at room temperature and humidity for one or hours, the change of varistor voltage shall be within 10%.			
Damp Heat Load/ Humidity Load	The specimen should be subjected to 40°C , 90 to 95%RH environment, and the maximum allowable voltage applied for 1000 hours, then stored at room temperature and humidity for one or two hours. The change of varistor voltage shall be within 10%.			
Low Temperature Storage	The specimen should be subjected to -40°C , without load for 1000 hours and then stored at room temperature for one two hours. The change of varistor voltage shall be within 10%.			

General Technical Data

Operating Temperature	$-55\sim 85^{\circ}\text{C}$
Storage Temperature	$-55\sim 150^{\circ}\text{C}$
Response Time	<1 ns
Solderability	$245\pm 5^{\circ}\text{C}$, 3 \pm 1sec
Solder Leach Resistance	$260\pm 5^{\circ}\text{C}$, 10 \pm 1sec

Surface Mount Multilayer Varistor

SV1812N380G0A

Packaging Information

Carrier Tape Dimensions

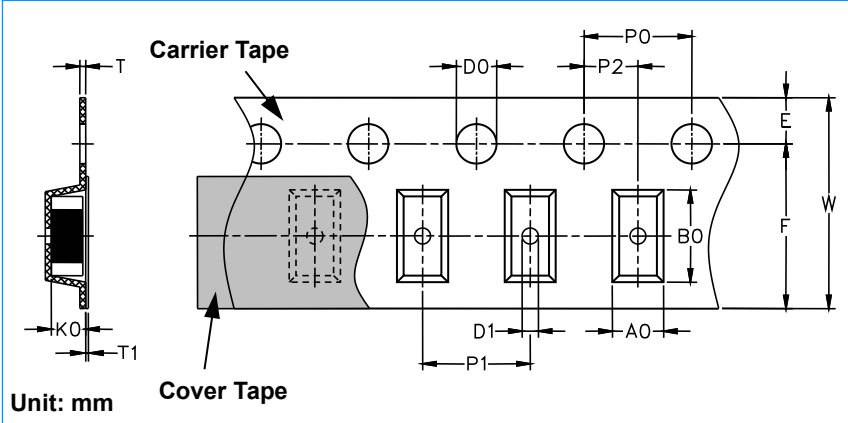

Carrier tape transparent cover tape should be heat-sealed to carry the products, and the reel should be used to reel the carrier tape.

The adhesion of the heat-sealed cover tape shall be 40+20/-15 grams.

Both the head and the end portion of taping shall be empty for reel package and SMT auto-pickup machine. And a normal paper tape shall be connected in the head of taping for the operator handle.

Symbol	A0 ±0.10	B0 ±0.10	K0 ±0.10	T ±0.05	T1 ±0.05	D0 +0.10 -0.00	D1 ±0.05	P1 ±0.10	P2 ±0.05	P0 ±0.050	W ±0.20	E ±0.10	F ±0.05
1812	3.66	4.95	1.74	0.25	0.10	1.50	1.50	8.00	2.00	4.00	12.00	1.75	5.50

Taping Reel Dimensions

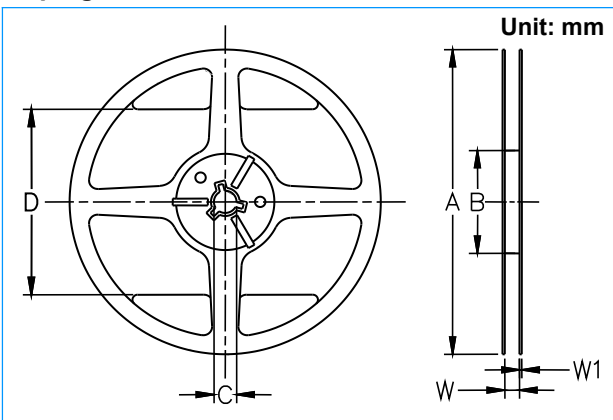

Symbol	A	B	C	D	W	W1
1812	178.0±1.0	60.0±0.5	13.0±0.2	110.0±0.5	13.6±0.5	1.5±0.15

Taping Specifications

There shall be the portion having no product in both the head and the end of taping, and there shall be the cover tape in the heat of taping.

Quantity of products in the taping package

SIZE EIA (EIAJ)	1812 (4532)
Standard Packing Quantity (PCS / reel)	1,000

The contents of a box :

1812 Series: 6 reels / inner box

Label and Marking:

The paper label shall be plastered on the obvious side of the reel, and the information show as right side